

DynaScan

User Manual

DS551LX4



Version 2.04

The use of diagrams and illustrations in the manual are for reference only. The actual product may be different.
Product design and specifications are subject to change without notice

Contents

Limited Warranty	2
Material Contents Declaration	3
Recycling and Energy Information	3
Declaration of Conformity	4
Safety Precautions	5
Important Safety Information	6
Getting Started	7
Contents	7
Installing and Replacing Remote Control Batteries	7
Installation.....	8
Mounting	8
Connecting to a Power Source.....	10
Connecting an External Video Source	10
Connecting Multiple Displays for Video Wall Applications	11
Input / Output Terminals	13
Operating Instructions	14
Powering On/Off the Display	14
Using the Remote Control	14
Using the Rear Panel Controls	17
Navigating the On Screen Display (OSD) Menu	18
Specifications	22
Input Mode.....	23
Pin Assignments.....	24
Digital RGB Output (DVI-D): DVI.....	24
Digital RGB Input (DVI-D): DVI	24
RS-232 Output.....	25
RS-232 Input	25
Troubleshooting.....	26

Limited Warranty

WARRANTY COVERAGE

DynaScan's warranty obligations are limited to the terms set forth below: DynaScan warrants its product against defects in materials and workmanship for a period of TWO (2) YEARS from the date of initial installation. If a defect exists, DynaScan will repair the product at no charge. A replacement part assumes the remaining warranty of the original product or NINETY (90) DAYS from the date of replacement or repair, whichever provides longer coverage for you. When a part is exchanged, any replacement item becomes your property and the replaced item becomes DynaScan's property.

OBTAINING WARRANTY SERVICE

You must contact DynaScan, identify the unit by model number, serial number and date of purchase, and furnish a brief description of the problem.

EXCLUSIONS AND LIMITATIONS

This Limited Warranty applies only to products manufactured by DynaScan that can be identified by the "DynaScan" trademark, trade name, or logo affixed to them. The Limited Warranty does not apply to any non-DynaScan products or any software, even if packaged or sold with DynaScan hardware. Non-DynaScan manufacturers, suppliers, or publishers may provide their own warranties. DynaScan and its Authorized Service Providers are not liable for any damage to or loss of data or other information stored on any media, or any non-DynaScan product or part not covered by this warranty. This warranty does not apply: (a) to damage caused by natural disasters, accident, abuse, misuse, misapplication, neglect; (b) to damage caused by service, including upgrades and expansions, performed by anyone who is not an DynaScan Authorized Service Provider; (c) to a product or a part that has been modified without the written permission of DynaScan; or (d) if any DynaScan serial number has been removed or defaced.

THIS WARRANTY AND REMEDIES SET FORTH ABOVE ARE EXCLUSIVE AND IN LIEU OF ALL OTHER WARRANTIES, REMEDIES AND CONDITIONS, WHETHER ORAL OR WRITTEN, EXPRESS OR IMPLIED. DYNASCAN SPECIFICALLY DISCLAIMS ANY AND ALL IMPLIED WARRANTIES, INCLUDING, WITHOUT LIMITATION, WARRANTIES OF MERCHANTABILITY AND FITNESS FOR A PARTICULAR PURPOSE. IF DYNASCAN CANNOT LAWFULLY DISCLAIM IMPLIED WARRANTIES UNDER THIS LIMITED WARRANTY, ALL SUCH WARRANTIES, INCLUDING WARRANTIES OF MERCHANTABILITY AND FITNESS FOR A PARTICULAR PURPOSE ARE LIMITED IN DURATION TO THE DURATION OF THIS WARRANTY. No DynaScan reseller, agent, or employee is authorized to make any modification, extension, or addition to this warranty.

DYNASCAN IS NOT RESPONSIBLE FOR DIRECT, SPECIAL, INCIDENTAL OR CONSEQUENTIAL DAMAGES RESULTING FROM ANY BREACH OF WARRANTY OR CONDITION, OR UNDER ANY OTHER LEGAL THEORY, INCLUDING BUT NOT LIMITED TO LOST PROFITS, DOWNTIME, GOODWILL, DAMAGE TO OR REPLACEMENT OF EQUIPMENT AND PROPERTY, ANY COSTS OF RECOVERING OR REPRODUCING ANY PROGRAM OR DATA STORED IN OR USED WITH DYNASCAN PRODUCTS, AND ANY FAILURE TO MAINTAIN THE CONFIDENTIALITY OF DATA STORED ON THE PRODUCT. DYNASCAN SPECIFICALLY DOES NOT REPRESENT THAT IT WILL BE ABLE TO REPAIR ANY PRODUCT UNDER THIS WARRANTY OR MAKE A PRODUCT EXCHANGE WITHOUT RISK TO OR LOSS OF PROGRAMS OR DATA.

Material Contents Declaration

Part Name	Hazardous Substances					
	Lead	Mercury	Cadmium	Hexavalent Chromium	Polybrominated Biphenyls	Polybromodiphenyl Ethers
	Pb	Hg	Cd	Cr ⁶⁺	PBB	PBDE
PCBA	○	○	○	○	○	○
CHASSIS	○	○	○	○	○	○
ACCESSORY	○	○	○	○	○	○
PACKAGE	○	○	○	○	○	○

“○” indicates that the level of the specified chemical substance is less than the threshold level specified in the standards of SJ/T-11363-2006 and EU 2005/618/EC.
“×” indicates that the level of the specified chemical substance exceeds the threshold level specified in the standards of SJ/T-11363-2006 and EU 2005/618/EC.

Recycling and Energy Information

DynaScan is firmly committed to its environmental protection efforts and we believe that reducing our products' impact on the environment is of the utmost importance. We are dedicated to meet the latest environmental protection regulations.

Energy usage

Mode	Energy Consumption
Normal	Max. 500 W
Standby	< 1 W

Disposal

Do not dispose of electrical appliances as unsorted municipal waste, use separate collection facilities. Contact your local government for information regarding the collection systems available. If electrical appliances are disposed of in landfills or dumps, hazardous substances can leak into the groundwater and get into the food chain, damaging your health and well-being. When replacing old appliances with new one, the retailer is legally obligated to take back your old appliances for disposal at least for free of charge.



Declaration of Conformity

FCC Verification

This device complies with Part 15 of the FCC Rules. Operation is subject to the following two conditions: (1) this device may not cause harmful interference, and (2) this device must accept any interference received, including interference that may cause undesired operation.

FCC Information

This equipment has been tested and found to comply with the limits for a Class A digital device, pursuant to Part 15 of the FCC Rules. These limits are designed to provide reasonable protection against harmful interference when the equipment is operated in a commercial environment. This equipment generates, uses, and can radiate radio frequency energy and, if not installed and used in accordance with the instruction manual, may cause harmful interference to radio communications. Operation of this equipment in a residential area is likely to cause harmful interference in which case the user will be required to correct the interference at his own expense.

Manufacturer Name DynaScan Technology Corp.

Manufacturer Address 7F, 66 Huaya 1st Road, Guishan, Taoyuan 33383, Taiwan



Safety Precautions

CAUTION	
	Do not install the display in a wet environment or place anything filled with liquid such as a vase or beverage on top of it.
	Do not install the display near flammable objects such as gasoline or other volatile liquids.
	Do not install the display near any heat sources such as radiators or other heating devices.
	Do not install the display in the dusty environment.
	Do not damage the power cord or plug.
	Do not disassemble the screen to avoid electric shock.
	The product can normally be operated at an altitude under 2000m. Abnormalities may occur when installing the device at an altitude above 2000m.

WARNING	
	Please power off the LCD and the video source before plugging in the DVI, DP or HDMI cable.
	Please installed the display in well-ventilated place, do not install in a confined space.
	Suitable for mounting on concrete or other non-combustible surface only.
	If it gives off smoke, strange smell, or unusual noise, or when it gets too hot to touch, immediately unplug the display and contact the dealer.
	Clean only with soft, dry cloth but not use chemical liquids, and unplug while cleaning.
	Do not use extreme force or any sharp or pointed objects to touch the display.
	Do not drop or allow any object to fall to the display.
	Do not operate the display with wet hands to avoid electric shock.
	Do not discard this product with general household waste. Please be sure to comply with the local waste regulations.
	This device uses, generates and radiated radio frequency energy. The radio frequency energy produced by this device is well below the maximum exposure allows by Federal Communications Commission (FCC).
	When a stationary or fixed image is displayed on the screen for a long time, the image may be permanently imprinted on the screen. This phenomenon is known as image burn-in and is not covered by the manufacturer's warranty.
	In order to avoid burn-in, avoid prolonged display of static or fixed images on the screen.

Important Safety Information

- Disassembling the LCD is strictly prohibited. Opening the cover may expose the user to electric shock or other hazards. Please contact DynaScan certified service professionals for all maintenance requirements.
- Do not allow any liquid to enter the LCD. Also avoid placing the LCD close to water sources.
- Do not place heavy objects on the power cord. A damaged power cord might cause electric shock or fire.
- Do not bend, twist, or damage the power cord.
- The power cord must comply with the local safety regulations.
- Do not damage or modify the prongs/pins and the ground contact on the power cord plug.
- Do not place the LCD on an unlevelled surface or an unstable vehicle. The LCD could fall over and cause substantial damage.
- Do not cover the vents and/or the heat sink.
- Do not install the LCD beside radiators or other heat sources. The installation site should have sufficient ventilation so the heat generated by the LCD can be dissipated.
- Do not use the Signage in a hot, humid, dusty, or fummy environment.
- Handle the LCD with care. Save the packaging materials for transport later.
- Clean the LCD backside at least once a month for dust and other particles.

Unplug the LCD immediately and contact a DynaScan certified service professional as soon as possible when any of the following situations occurs:

- Damaged power cord or power plug.
- If liquid or foreign object has entered the LCD.
- If the LCD has been exposed to rain or water.
- If the LCD has been dropped or the casing has become damaged.
- If any structural damage such as cracks or unnatural vibration is found.
- If the LCD cannot be operated following the steps outlined in this manual.
- If the LCD emits smoke or other odors, or generates strange noises.

Operating Suggestions

- Avoid displaying a stationary image for a long period of time in order to prevent image sticking.

Cleaning the Panel

- Use a soft, lint-free cloth to gently wipe the dust off from the screen panel.
- Do not use any hard material to wipe the panel.
- Do not poke the panel with your hand or any sharp object (such as a pen or a nail) or exert excessive pressure on the panel to prevent any damage.
- Do not use any cleaning solutions on the panel as it might cause discoloration.

Cleaning the Casing

- Unplug the power cord.
- Gently wipe the casing with a soft cloth.

Attention

- Do not use any of the following solutions to clean the casing as they may damage the paint and cause it to crack or peel: benzene solution, alkaline solution, alcohol-based cleaning solution, glass cleaner, wax, polisher, or detergent.



Getting Started

Contents

Confirm that the accessories below are shipped along with the display. If any item is missing, please contact your dealer. The color and shape of the accessories may vary with the products.

- DS551LX4 Professional LCD
- Remote Control x 1 pc.
- Batteries (1.5V / AAA) x2 pcs.
- Quick Start Guide x1 pc.
- Power cable x1 pc.
- RS-232 cable x1 pc.
- DVI cable x1 pc.
- Ethernet crossover cable x1 pc.

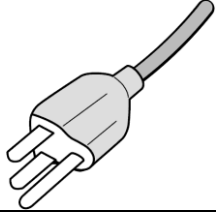
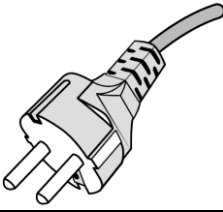
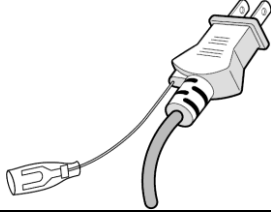
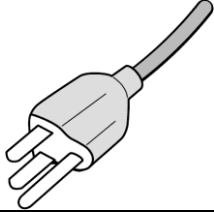
Attention: Please use the following table to check whether the included power cord is suitable for your region. If the power cord does not match your region, please contact your local supplier. Please use matching AC socket in order to meet your local safety regulations.

Plug Type	North America	European Continental	Japan	Taiwan
Plug Shape				
Region	U.S.A. / Canada	EU (Except U.K.)	Japan	Taiwan
Voltage	120V	230V	100V	110V
NEMA TYPE	NEMA 5-15	CEE 7/7	NEMA 1-15	NEMA 5-15
IEC Display Plug				
IEC Plug TYPE	IEC320 C13			

Installing and Replacing Remote Control Batteries

1. Open the battery compartment cover.
2. Insert 2 new AAA batteries.
3. Close the battery compartment cover.

Warning:

- Incorrect usage of batteries may cause leakage or explosion.
- Pay attention to the polarity when installing the batteries.
- Do not mix different types of batteries or new and used batteries. Doing so may shorten the battery life or cause leakage.
- Remove or replace the batteries when they are empty in order to prevent acid leaking in the battery compartment.
- Do not touch the leaked substance from the batteries in case of a battery leakage. Doing so may hurt human skin.

Note: If the remote control is not going to be used for a long time, we recommend removing the batteries from the remote control.

Installation

The LCD must be properly installed using a wall mount. Incorrect installation may cause injury or damage the equipment. Product warranty does not cover the damage caused by improper installation and DynaScan shall not be held responsible for such incident.

Mounting

- Hanging the Professional LCD from the ceiling or mounting it on the wall is the responsibility of the user. Not all ceilings or walls provide enough strength to support the LCD. The LCD may drop and cause serious injury if it is hanging from the ceiling with insufficient support or is mounted on a slanted wall. Product warranty does not cover improper installation, modification, or damage caused by natural disasters. DynaScan recommends having certified professionals to evaluate the installation site and perform the mounting operation.
- Do not to cover the vent and/or the heat sink in order to ensure proper heat dissipation.
- Refer to the installation guide provided by the manufacturer for proper mounting.

When mounting on a wall or hanging from a ceiling

- A wall mount is not included in the accessory. Please purchase a VESA Standard wall mount to secure the LCD. DynaScan is not responsible for the damage caused by using non-standard wall mounts.
- Verify that the mounting location can support the weight of the LCD before installation.
- The installation angle must be within 15 degrees of the vertical axis.
- Do not install the wall mount while the power is turned on as it may cause serious injury due to electrical shock.

Model Number	VESA (mm)		Screw Specification	Screw Length	Number
DS551LX4	(A * C)	600 * 400	M6	Greater than 10mm Smaller than 12mm (not including wall mount thickness)	8
	(B * C)	400 * 400			

DS551LX4

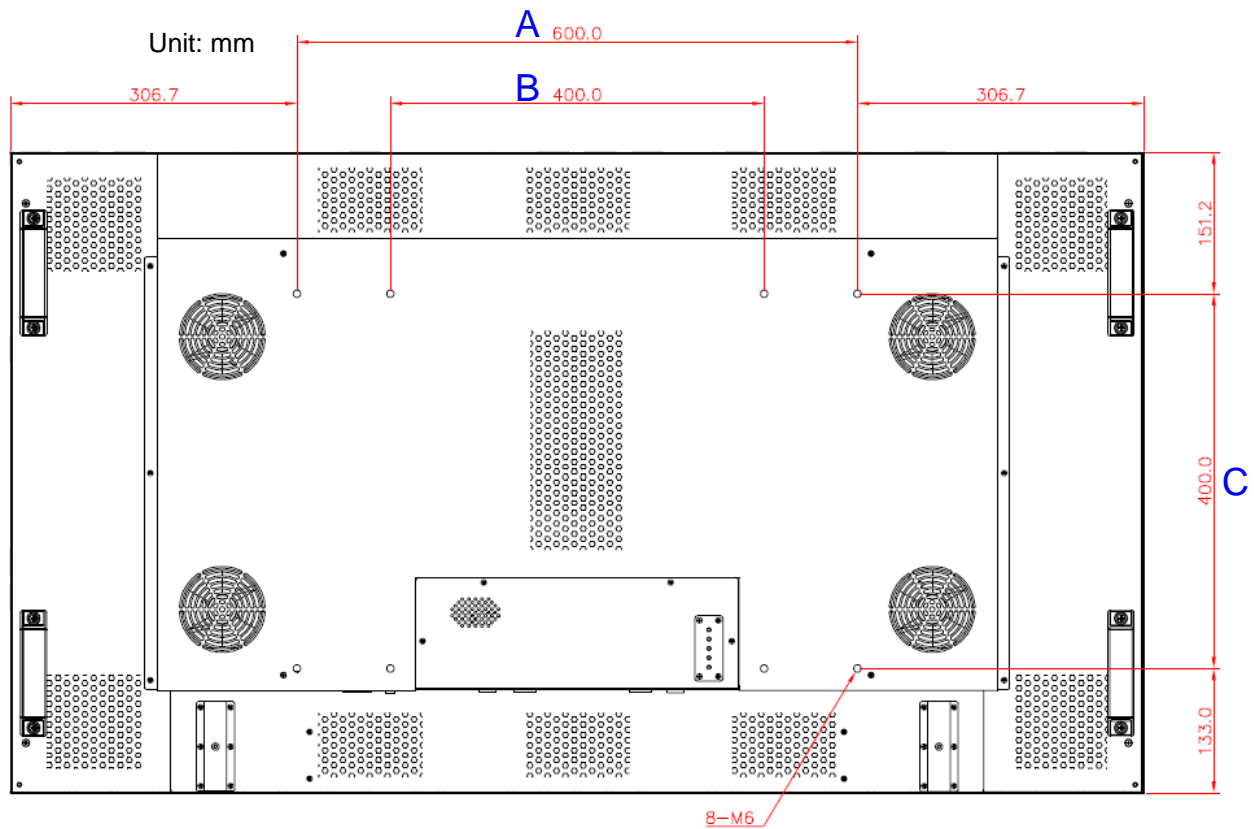

Orientation

- When using the LCD in portrait orientation, it should be turned clockwise so that the left edge becomes the top edge.

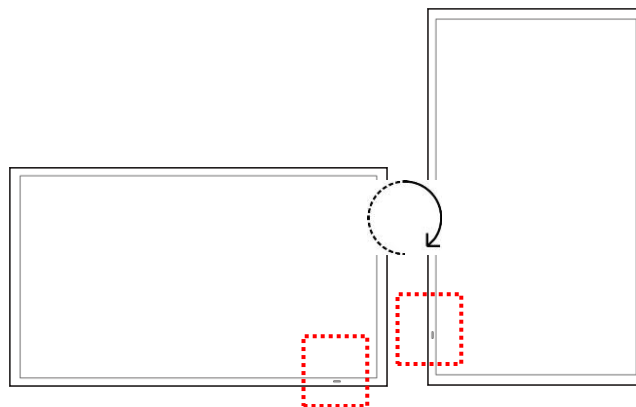

Portrait mode: Rotate the set clockwise 90° (mandatory)

Installation Location

- The ceiling or the wall must have enough strength to support the LCD and its accessories.
- Do not install the LCD in a location with strong vibrations or is dusty.
- Do not install the LCD near the building's main electric panel.
- Do not install the LCD at a location where it can be easily removed by the general public.
- When the LCD is installed in an alcove, leave at least 10cm (4") of space around it to ensure proper ventilation.

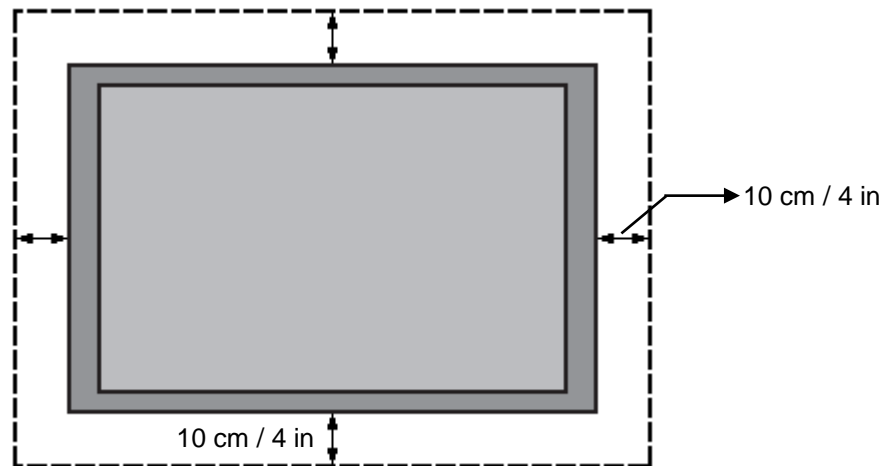

When hanging from a ceiling

- Ensure that the ceiling is strong enough to support the LCD and its accessories. Earthquake, unexpected vibration and other external forces should be taken into consideration when evaluating the ceiling strength.
- The LCD should be secured to the building's structural frame such as a beam rather than light steel frame or interior decoration.
- Do not use wood screws or dry wall anchors for installation.

Maintenance

- Inspect the fasteners regularly for signs of loosening or deformation. Please perform appropriate corrective measures when a problem is identified. Neglecting the problem may worsen the situation.
- Increase the inspection frequency on areas where previous maintenance had occurred to ensure the problems do not occur again.

Connecting to a Power Source

Using the power cable provided, plug it in the power inlet on the back of the display shown in the diagram below. Connect the power cable to a 100-240 volt, 50 / 60Hz AC power outlet.



Insert the plug completely into the socket. A loose power connection may cause damage to the display and/or lead to a fire hazard.

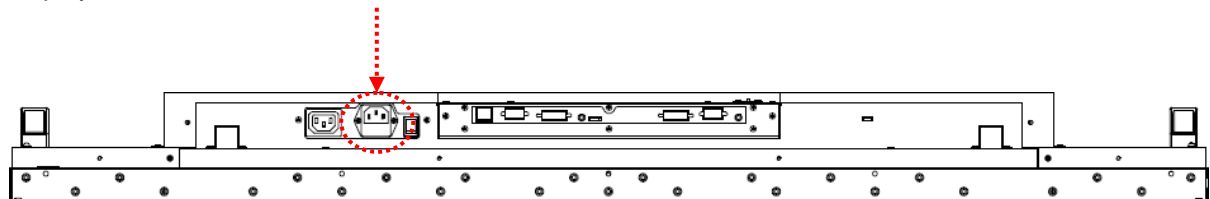

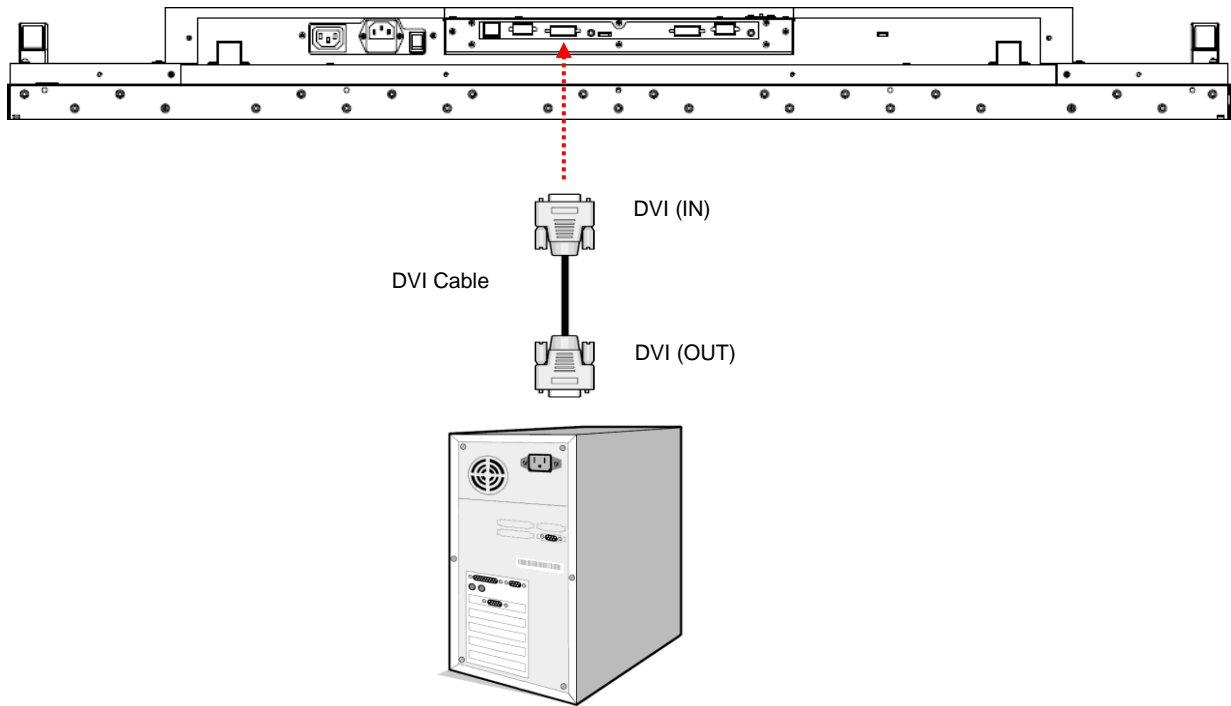

Connecting an External Video Source

Turn OFF the power of both LCD and external video device. Using the DVI cable provided, insert one end into the DVI-IN on the back of the display shown in the diagram below. Connect the other end of the DVI cable to the DVI output of the video source. Refer to your video device's manual for additional information.



Connecting Multiple Displays for Video Wall Applications

To daisy chain multiple displays for a video wall application, connect a video source to the 1st display into the chain with the supplied DVI cable and RS-232 cable. Connect the DVI-OUT of the 1st display to the DVI-IN of the 2nd display. Using the RS-232 cable provided, connect the RS-232 OUT of the 1st display to the RS-232 IN of the 2nd display. Repeat the connection for the remaining displays. Use the OSD Menu or Display Manager software to configure the size of the video wall and the position of each display.

-  **Note:** The maximum number of DS551LX4's in a Video Wall is 15x15.
-  **Note:** The DynaScan "Display Manager" application is required to be installed on the PC in order to use the External Control feature.
-  **Note:** The Daisy Chain Setting (video wall function) only supports a resolution of 1920 x 1080 (1080p).

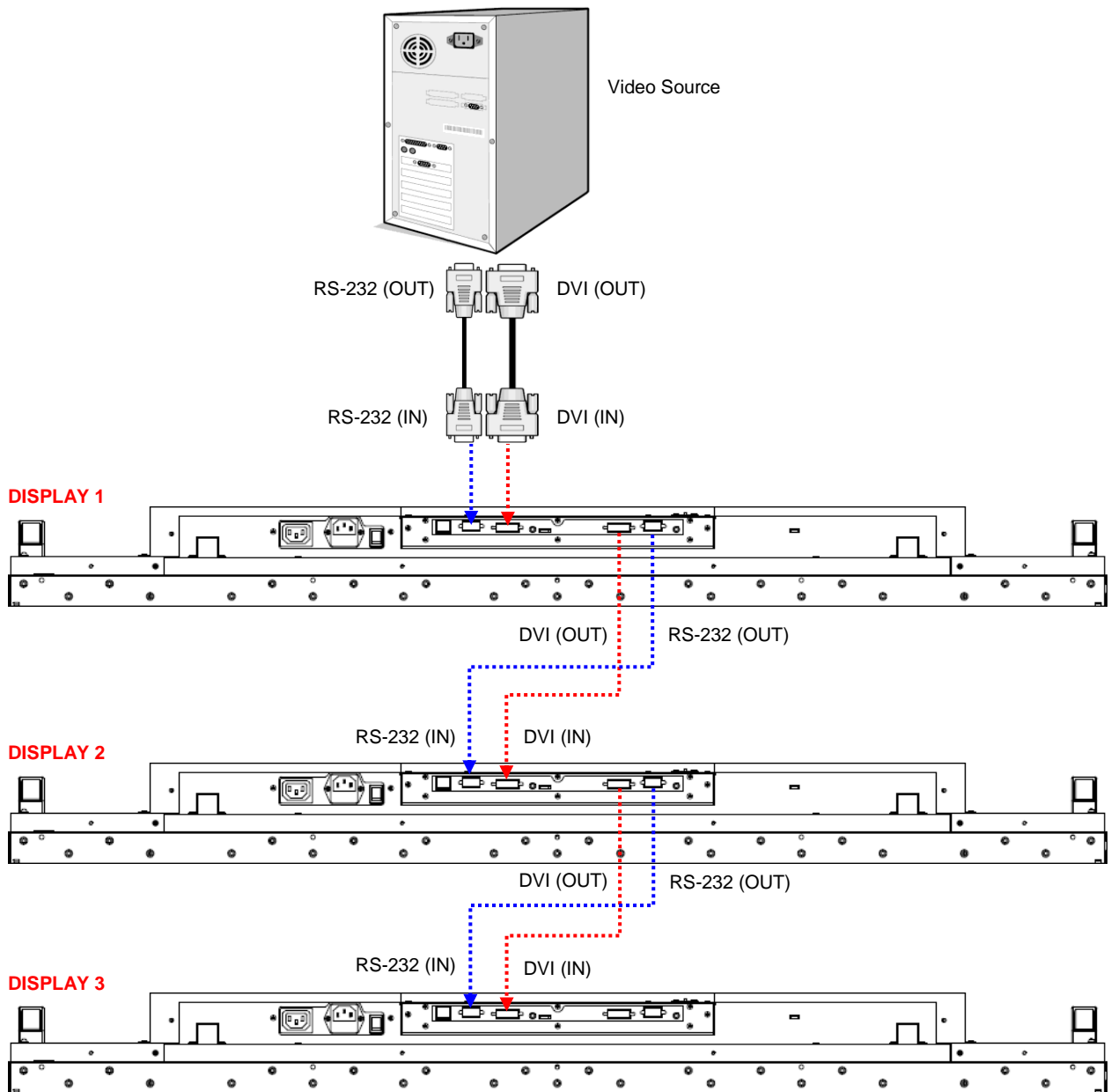

Input / Output Terminals

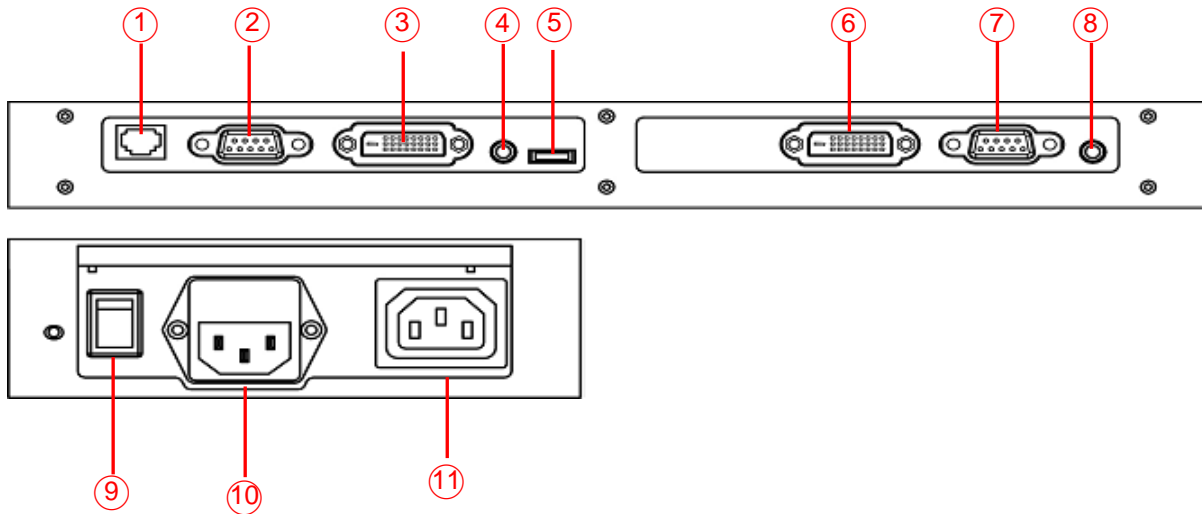

1. **RJ-45 (IN):** RJ45 network input connection for remote control from PC.
2. **RS-232 (IN):** RS232C network input connection for remote control from PC.
3. **DVI (IN):** Connect the DVI-D output of a PC, or the HDMI output of an AV device via a DVI-HDMI cable.
4. **Audio (IN):** Connect the audio input from an external AV device.
5. **Extension Connector:** Extension Connector for optional IR Extension sensor kit (ESK201).
6. **DVI (OUT):** Output the signal from DVI IN.
7. **RS-232 (OUT):** RS232 control function for daisy chain application.
8. **Audio (OUT):** Connect the audio signal output from Audio IN jack to an external AV device.
9. **Power Switch:** Press to switch the main power on/off.
10. **AC (IN):** Connect the supplied power cord to the wall outlet.
11. **AC (OUT):** AC outlet 100~240V up to 100 Watt.

DS551LX4

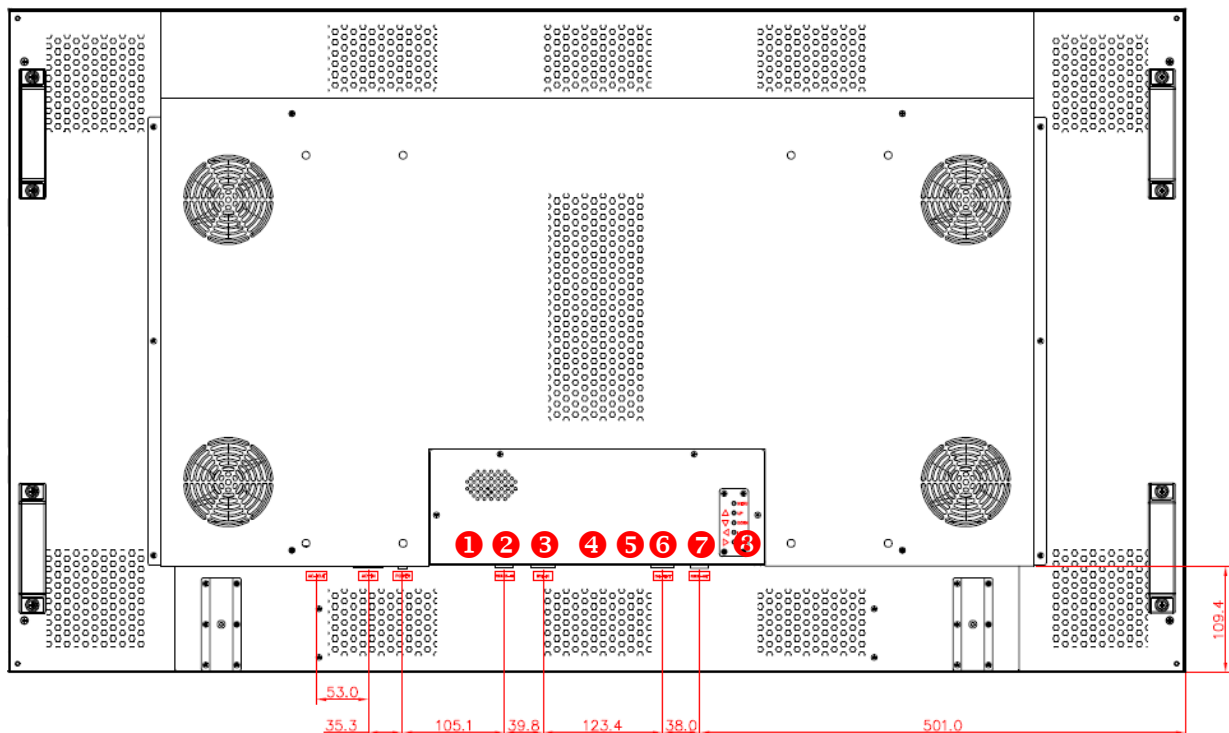

Operating Instructions

Powering On/Off the Display

To turn on/off the display, press the power switch on the back of the display as shown in the diagram below.

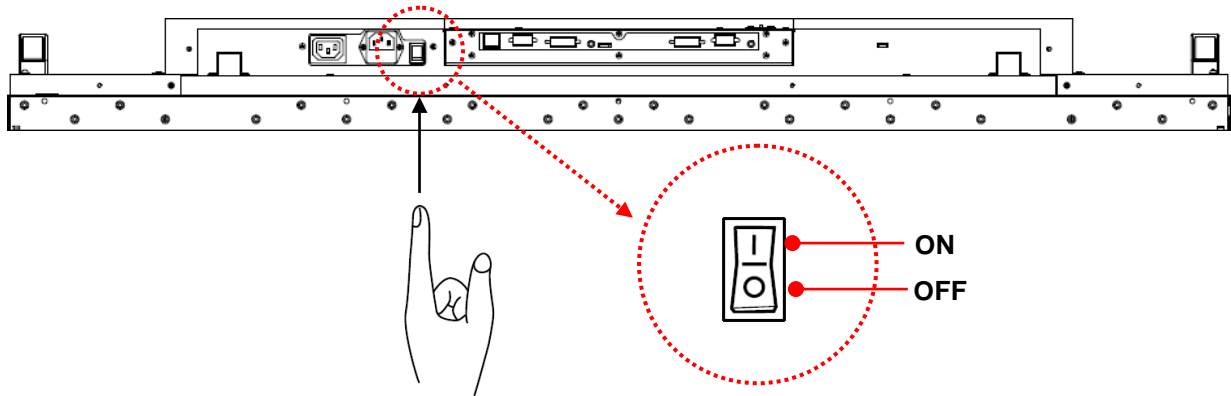

NOTE: The remote control only works when the power switch is ON.

Using the Remote Control

When using the remote control, aim the remote at the IR receiver on the display. The IR receiver on the DS551LX4 model is at the rear of the display with a receiving angle of 100 degrees. The IR receiver configurations of the model are shown in the figure below.

The operating range of the remote control is 2.5 meters (8 feet).

Ambient light may affect the performance of the remote control. Avoid fluorescent or neon lights in the vicinity.

DS551LX4

Unit: mm

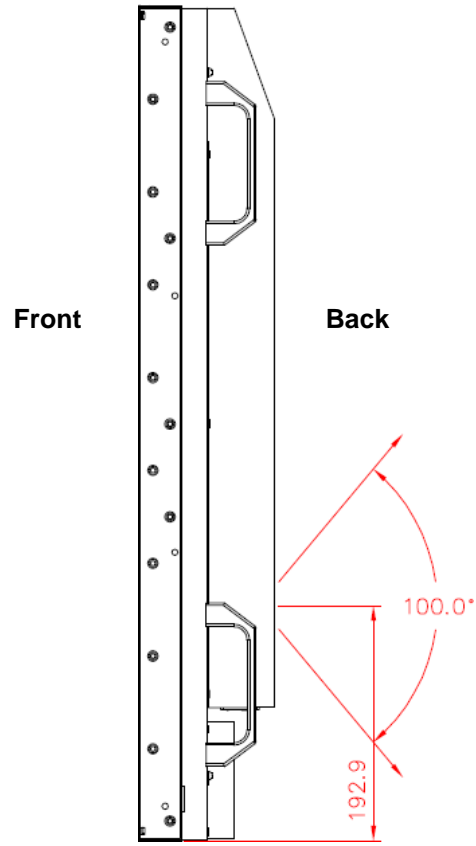

Using the Remote Control (cont.)

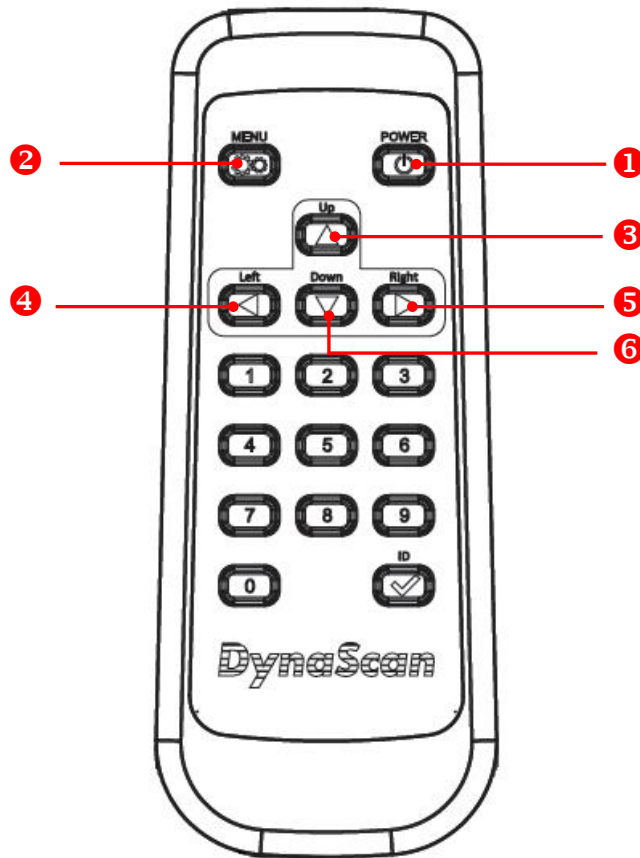

Color and shape may vary by model.

ITEM		DESCRIPTION
①	POWER	Power On / Off
②	MENU	OSD On / Off
③	UP	Move the cursor up or change the setting of selected item.
④	LEFT	Exit the current selection.
⑤	RIGHT	Select the highlighted item.
⑥	DOWN	Move the cursor down or change the setting of selected item.

Using the Rear Panel Controls

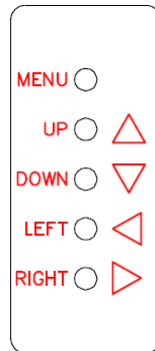
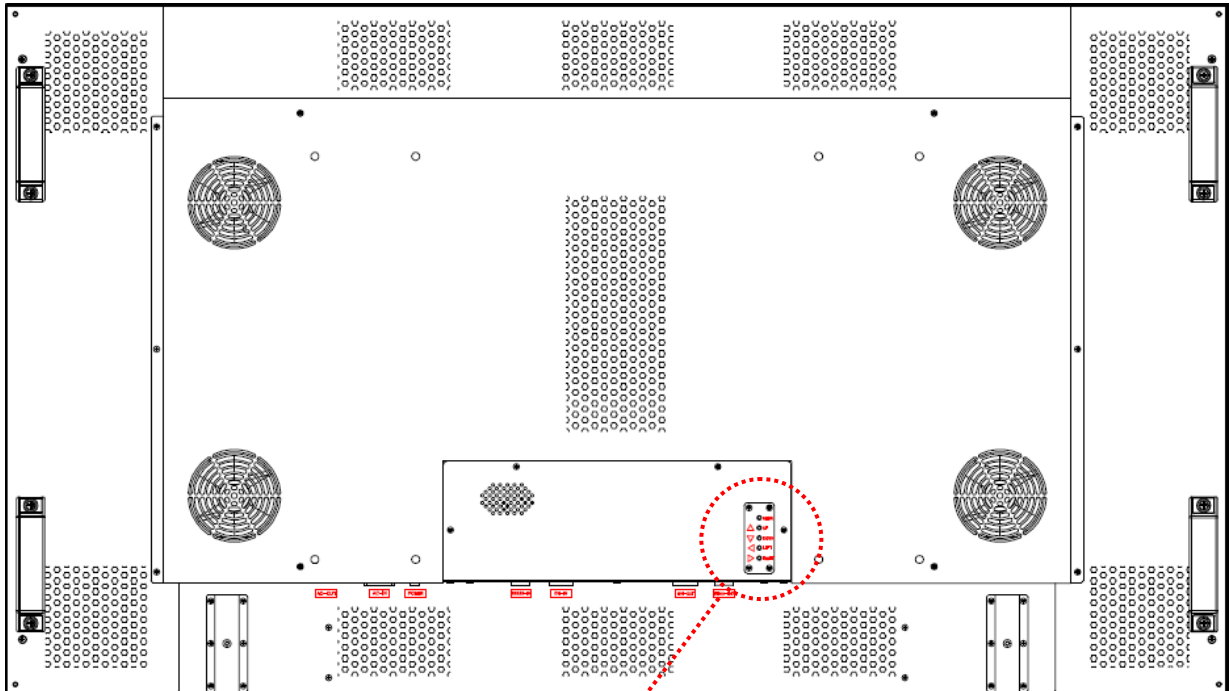

ITEM	DESCRIPTION
MENU	OSD On / Off, Power On / Off.
UP	Move the cursor up or change the setting of selected item.
DOWN	Move the cursor down or change the setting of selected item.
LEFT	Exit the current selection.
RIGHT	Select the highlighted item.

Navigating the On Screen Display (OSD) Menu

Press the MENU button on either the rear panel control or remote control to show the OSD. Use the navigation arrows to select and adjust the menu items.

Picture	Color Temperature	D65
Time	R	100
Video Wall	G	100
Backlight	B	100
Network	Contrast	50
Advance	Gamma	Native
Information 1		
Information 2		

ITEM 1	ITEM 2	DEFAULT	DESCRIPTION
Picture	Color Temperature	D65	Select the color temperature. (User, D93, D65 and D55).
	R	100	Adjust the red light level. Range 0 – 100.
	G	100	Adjust the green light level. Range 0 – 100.
	B	100	Adjust the blue light level. Range 0 – 100.
	Contrast	50	Adjust the contrast level. Range 0 – 100.
	Gamma	Native	Adjusts the Gamma value.

Picture	Current Time	10:00
Time	Power Control Timer	Off
Video Wall	Power On Time	00:00
Backlight	Power Off Time	00:00
Network		
Advance		
Information 1		
Information 2		

ITEM 1	ITEM 2	DEFAULT	DESCRIPTION
Time	Current Time	HH:MM	Set the clock. Note: The internal clock will continue to function when the power is turned off.
	Power Control Timer	Off	Turn on / off automatic power schedule function.
	Power On Time	HH:MM	Set turn-on time.
	Power Off Time	HH:MM	Set turn-off time.

Picture	Number of Rows	01
Time	Number of Columns	01
Video Wall	Row Position	01
Backlight	Column Position	01
Network	Bezel Compensation	On
Advance		
Information 1		
Information 2		

ITEM 1	ITEM 2	DEFAULT	DESCRIPTION
Video Wall	Number of Rows	1	Set number of rows in a video wall. Note: The maximum number of rows in a daisy chain is 15.
	Number of Columns	1	Set number of columns in a video wall. Note: The maximum number of columns in a daisy chain is 15.
	Row Position	1	Vertical position in a video wall.
	Column Position	1	Horizontal position in a video wall.
	Bezel Compensation	On	Choose to turn the frame compensation function on or off. When turned on, the display will adjust the image to compensate the width of display bezels in order to accurately display the image.

Picture	Auto Brightness	Off
Time	High Level	100
Video Wall	Low Level	50
Backlight	High Level Time	00:00
Network	Low Level Time	00:00
Advance	Local Dimming	High
Information 1		
Information 2		

ITEM 1	ITEM 2	DEFAULT	DESCRIPTION
Backlight	Auto Brightness	Off	To turn On / Off the auto brightness adjustment. Note: If the AUTO BRIGHTNESS is off, the screen brightness will remain at HIGH LEVEL brightness value. If the AUTO BRIGHTNESS is on (Auto), the display brightness adjusts according to the ambient light. When ambient light is bright, the screen will adjust to the HIGH LEVEL brightness value set; when ambient light is dark, the screen will adjust to the LOW LEVEL brightness value set. When the Timer mode is set, the display will automatically switch the brightness according to the time set.
	High Level	100	Adjusts the highest brightness level. Range 0 – 100.
	Low Level	50	Adjusts the lowest brightness level.

			Range 0 – 100.
	High Level Time	HH:MM	Set high level time.
	Low Level Time	HH:MM	Set low level time.
	Local Dimming	High	Adjusts the contrast. High is the highest contrast. Off is the lowest contrast.

Picture	DHCP	On
Time	IP	192.168. 0.100
Video Wall	Mask	255.255.255. 0
Backlight	Gateway	192.168. 0. 1
Network		
Advance		
Information 1		
Information 2		

ITEM 1	ITEM 2	DEFAULT	DESCRIPTION
Network	DHCP	On	Choose to enable or disable the DHCP function. If enabled, the display will assign the IP address, Subnet mask and Default gateway automatically. If disabled, the following values will be entered manually.
	IP	192.168.0.100	Assign IP address.
	Mask	255.255.255.0	Assign Subnet mask.
	Gateway	192.168.0.1	Assign Default gateway.

Picture	Display Mode	Landscape
Time	Screen Saver	Off
Video Wall	Remote Control	RS232
Backlight	IR Control	On
Network	Power Off Mode	Standby
Advance	Reset to Default Setting	Off
Information 1		
Information 2		

ITEM 1	ITEM 2	DEFAULT	DESCRIPTION
Advance	Display Mode	Landscape	Change the Menu orientation. The Menu can be displayed in either LANDSCAPE or PORTRAIT mode.
	Screen Saver	Off	Turn on / off image burn-in protection. Set image burn-in protection interval.
	Remote Control	RS232	Choose to use the remote control function RS232 or Network.
	IR Control	On	Enable/disable the remote control for Menu. Note: When disabled, the remote control function can be enabled again from the control panel on the display or through the DynaScan "Display Manager" application.
	Power Off Mode	Standby	When in Power Off Mode, RS-232 controls do not function. Only [Main Power Switch] on the display or [Power Button] on the remote control can wake up the display.

	Reset to Default Setting	Off	Restore all settings to default. Note: It does not modify CURRENT TIME, POWER ON TIME and POWER OFF TIME.
--	--------------------------	-----	---

Picture Time Video Wall Backlight Network Advance Information 1 Information 2	Resolution Model Serial Number Over Heat Protection Fan Alarm	1920x1080 60Hz DS551LX4 551LX4XXXXXXXXX Mode 0
--	---	---

ITEM 1	ITEM 2	DEFAULT	DESCRIPTION
Information 1	Resolution	1920x1080	Input resolution.
	Model	DS551LX4	The display's model.
	Serial Number		The display's serial number.
	Over Heat Protection	Not displayed	It will enter into protection mode when the display internal temperature is over heat. Mode 0 = Brightness 50%. Mode 1 = Brightness 25%. Mode 2 = Brightness 03%. When the temperature is decreased to exit the protection, the brightness will restore to 100% and Over Heat Protection is disabled.
	Fan Alarm	Not displayed	When any of the cooling fans on the display rear side is failure and stops running, the Fan Alarm will appear and blink, and reduce the brightness to 25%. Be sure to contact the service engineer for repair.

Picture Time Video Wall Backlight Network Advance Information 1 Information 2	Hardware Firmware	XXXXX X.X.X
--	----------------------	----------------

ITEM 1	ITEM 2	DEFAULT	DESCRIPTION
Information 2	Hardware		The H/W version.
	Firmware		The F/W version.

Some functions may not be available for all models.



*Adjusted value: Each R/G/B value for this product has been individually adjusted during production to a preset color temperature of 6500K.

Specifications

MODEL		DS551LX4
PANEL	LCD Panel Size	54.6 inches
	Native Resolution	1920 x 1080
	Brightness	3000 cd/m ² (Typ.)
	Contrast Ratio	3,000:1 (Static) 1,000,000:1 (Dynamic)
	Response Time	12 ms (Typ.)
	Viewing Angle	178°/ 178°
	Life Time	50,000 hrs (Typ.)
	Panel Surface	AG, Haze 10%, 3H
POWER	Power Supply	Internal
	Rated Voltage	100 ~ 240V, 50 / 60Hz
	Power On Mode	Typ. 300W / Max. 500W
	Standby Mode	< 1W
	AC Out	< 100W
MECHANICAL SPECS	Bezel Width (T/B/L/R)	1.25/2.25/2.25/1.25 mm
	Cabinet Color	Black
	Monitor Dimension (LxHxD, w/o Stand)	1213.4 x 684.2 x 110.5 mm
	Monitor Weight (set / package)	40 kg / 46 kg
	VESA Mounting (Dimension)	8 Holes (400x400 mm / 600 x 400 mm)
USER INTERFACE	OSD Language	English
ENVIRONMENT	Operation Temperature	0°C ~ 45°C
	Storage Temperature	-20°C ~ 60°C
	Humidity	10%~80% RH Non-Condensing
I/O Ports	DVI-D	IN *1 / OUT *1 (support HDMI)
	RS-232	IN *1 / OUT *1
	RJ-45	IN *1
	Audio	IN *1 / OUT *1
Fuse		8A

 Design and specifications are subject to change without notice.

 The resolution of DVI-D out is 1920 x 1080 (1080p) only.

Input Mode

Active Resolution		Refresh Rate	Pixel Rate	Aspect Ratio
H Pixels	V Lines			
640	480	60 Hz	25.175 MHz	4:3
720	480	50 Hz	27 MHz	4:3
		59.94 Hz	27 MHz	4:3
800	600	60 Hz	40 MHz	4:3
1024	768	60 Hz	65 MHz	4:3
1280	720	50 Hz	74.25 MHz	16:9
		60 Hz		
1280	768	60 Hz	79.5 MHz	5:3
1360	768	60 Hz	85.5 MHz	16:9
1920	1080	50 Hz	148.5 MHz	16:9
		60 Hz		

Pin Assignments

Digital RGB Output (DVI-D): DVI

PIN ASSIGNMENT OF DVI CONNECTOR					
01	TX2-	09	TX1-	17	TX0-
02	TX2+	10	TX1+	18	TX0+
03	Shield (TX2 / TX4)	11	Shield (TX1 / TX3)	19	Shield (TX0 / TX5)
04	NC	12	NC	20	NC
05	NC	13	NC	21	NC
06	DDC-Serial Clock	14	+5V power	22	Shield (TXC)
07	DDC-Serial Data	15	Ground	23	TXC+
08	NC	16	Hot plug detect	24	TXC-

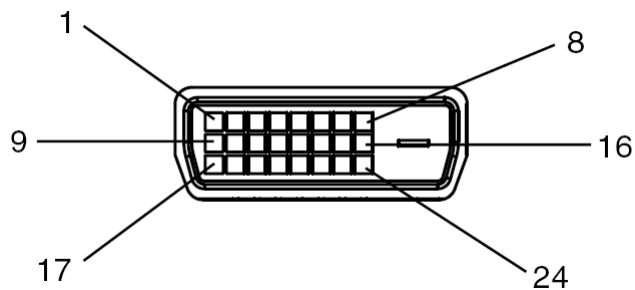

Digital RGB Input (DVI-D): DVI

PIN ASSIGNMENT OF DVI CONNECTOR					
01	RX2-	09	RX1-	17	RX0-
02	RX2+	10	RX1+	18	RX0+
03	Shield (RX2 / RX4)	11	Shield (RX1 / RX3)	19	Shield (RX0 / RX5)
04	NC	12	NC	20	NC
05	NC	13	NC	21	NC
06	DDC-Serial Clock	14	+5V power	22	Shield (RXC)
07	DDC-Serial Data	15	Ground	23	RXC+
08	NC	16	Hot plug detect	24	RXC-

RS-232 Output

PIN No.	NAME
01	Connected to 7&8
02	RXD
03	TXD
04	Connected to 6
05	GND
06	Connected to 4
07	Connected to 1&8
08	Connected to 1&7
09	NC

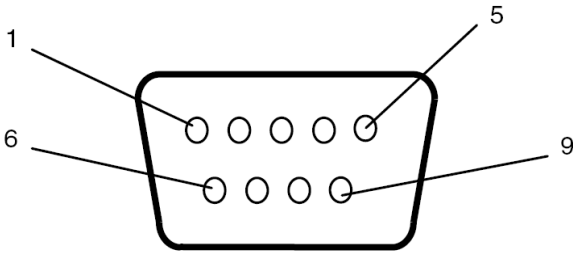

RS-232 Input

PIN No.	NAME
01	Connected to 7&8
02	TXD
03	RXD
04	Connected to 6
05	GND
06	Connected to 4
07	Connected to 1&8
08	Connected to 1&7
09	NC

Troubleshooting

ISSUE	RECOMMENDED SOLUTION
No image is displayed.	<ul style="list-style-type: none"> • Check whether the DVI in cable is completely plugged in. • Check whether the main switch is in the ON position, and the power cord is completely plugged in. • Check whether the image source's resolution is set to 1920 × 1080 (1080p). • Check whether the DVI cable is damaged or bent excessively.
Nothing happens when switching the main switch on.	<ul style="list-style-type: none"> • Unplug the power cord from the socket and plug it in again after a few seconds to reset the Signage. <p>Note: Unplugging the power cord will not change the settings.</p>
Image is unstable.	<ul style="list-style-type: none"> • Check whether the DVI in cable is completely plugged in.
The remote control does not work.	<ul style="list-style-type: none"> • Check whether there are batteries in the remote control. • Check the batteries for freshness, polarity, etc. • Check whether the remote is in the operation range. • Bright light may interfere with the remote control. Please avoid using the remote control near special fluorescent lights or neon lights.
Auto on/off does not work or does not function properly.	<ul style="list-style-type: none"> • Check whether the TIMER setting in the menu is set to "OFF". • Check whether the "Power On Time" and "Power Off Time" settings are set correctly.
Cannot control the display remotely via RS-232.	<ul style="list-style-type: none"> • Check whether the RS-232 cable is connected properly.

If you are still having trouble with your DynaScan DS² Professional LCD, contact your dealer or DynaScan directly for more assistance.

www.dynascanusa.com